

Growing innovation.

GroPoint Profile

Multi-segment soil moisture and temperature profiling probe

GroPoint™ Profile provides cost-effective measurement of volumetric water content over multiple depths using a single probe, eliminating the cumbersome excavation required for multiple sensors placed at different depths. It can be deployed in irrigation-sensitive zones to enable full control of precision irrigation needs, providing an understanding of water movement through the soil.

The sleek, lightweight design installs quickly with minimal soil disruption using a pilot rod and slide hammer tool. Designed for vertical installation, the sensor takes measurements across multiple soil layers, with each measurement zone (segment) providing the average volumetric soil moisture content over a 15 cm range (approximately 6 inches).

Our proprietary TDT5 technology delivers an **exceptional price:performance ratio**, with performance as good (in most cases better) as sensors costing much more.

- ✓ Eliminates need for multiple sensors and cabling systems.
- ✓ Installs quickly and easily without excavating.
- ✓ One SDI-12 address is used to read all segments, providing for simplified installations. Optional RS-485 output.
- ✓ Moisture readings can be user-calibrated with 3rd-order polynomials to meet custom requirements.
- ✓ Low power requirements—suitable for remote, autonomous applications.
- ✓ Patented TDT⁵ technology for scientific-grade accuracy and excellent long-term stability of measurements.
- ✓ Fully potted electronics for excellent durability.



TDT⁵

GroPoint's patented technique for soil moisture measurement

Our proprietary TDT⁵ technology delivers an exceptional price:performance ratio, with performance as good (in most cases better) as sensors costing much more.

GroPoint™ sensors are based on the field-proven Time Domain Transmission (TDT) method of reliably measuring soil moisture, which is a refined version of Time Domain Reflectometry (TDR). TDT-based sensors do not need to be calibrated to each type of soil they will be buried in. Some of the best soil sensors utilize this method. **TDT⁵ enhances TDT in 5 key ways:**

Antenna length per segment: 15cm
Effective length (if stretched out): 75cm

1: Accurate across entire length

Our patented design weaves the antenna through the circuit board 20 times per centimetre, and much like a coiled spring, the effective length of the antenna is **5 times the physical length** it consumes. It's

like having a 75cm long antenna in a single 15cm sensor. A larger antenna increases the resolution of each sample, allowing more noise to be filtered out. This gives highly accurate tracking of moisture changes with no "dead spots".

2: Reduced manufacturing cost

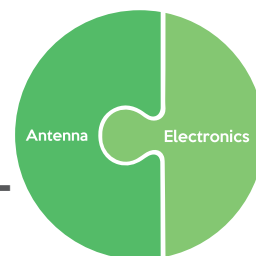

Unlike other moisture probes, GroPoint sensors do not have separate components for electronics and bulky metal antennas. By integrating the antenna and all electronics into the same circuit board (possible thanks to the patented antenna design), manufacturing costs are dramatically reduced.

3: Repeatable accuracy

Each time a measurement is taken, GroPoint sends 400,000 pulses through the sensing element to generate data for the measurement, then employs advanced filtering to eliminate outlying readings (noise) before averaging the data and sending the measurement as SDI-12 output. This ensures that the same extreme accuracy ($\pm 1\%$) is obtained each and every time moisture is measured.

400,000 pulses filtered per measurement

4: Low power consumption

Even with 400,000 pulses for each measurement, the total time to take the measurement is less than 100 ms. This means that power consumption is minimal, and that permits GroPoint sensors to be operated for many months with small 9V battery-powered data loggers.

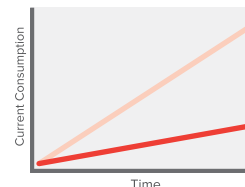

5: Maximum durability

Unlike typical sensors, the antenna is not exposed to the soil, so there's nothing to bend or break. The entire sensor circuit board (including antenna) is sealed in epoxy, then encased in a sealed polycarbonate housing.

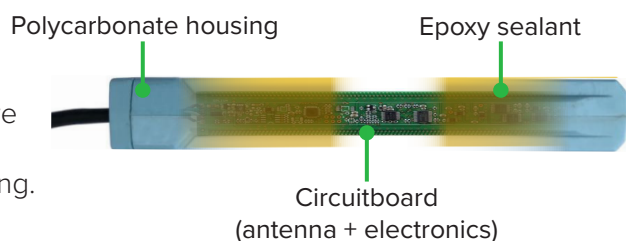

Soil Moisture Probe Technology

Patented TDT technology that provides accurate, repeatable soil moisture (and optionally soil temperature) measurements from the soil surface up to a depth of 120cm (4ft). The GroPoint™ Profile uses patented sensing antennas across each 15cm (6 in.) segment to provide a complete soil moisture profile. Each sensing element can be configured/calibrated individually to ensure accurate measurements across different soil types/horizons. Soil temperature sensors are located every 10 or 15 cm, depending on the number of segments chosen.

Available with Modbus, SDI-12 and RS485 interfaces, in lengths of 30cm, 45cm, 60cm 75cm and 120cm; a single cable transmits all measurements. No access tubes or excavation are needed for installation in permanent and temporary installations.

Temperature Sensor Placement

Choose the number of 15cm segments that are right for your application.

The standard configuration places temperature sensors every 10 or 15 cm, depending on the number of segments.

 = temperature sensor placement

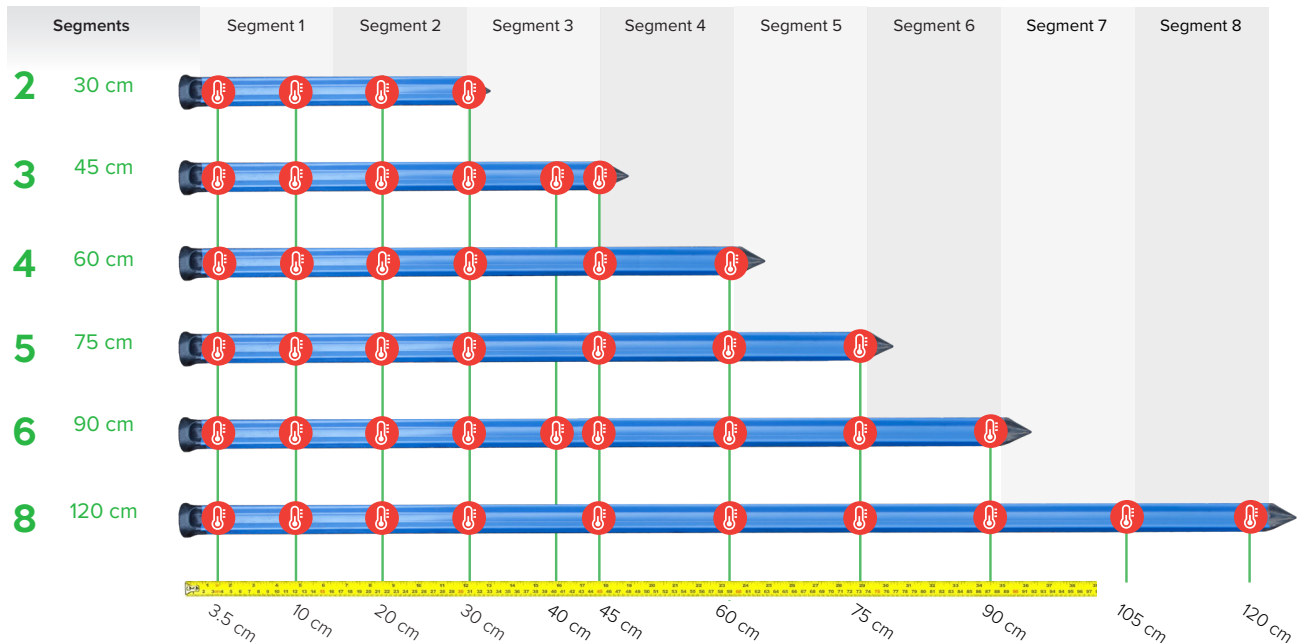

Ordering

Specify cable and connection interface at order.

Cable Connection: Either flying lead or M12 Connector, **Interface:** SDI-12, modbus or RS485 + SDI-12

Length & Number of Segments	Part No. With Temperature	Part No. Without Temperature
2 Segment (30 cm)	2625-S-T-2	2625-S-2
3 Segment (45 cm)	2625-S-T-3	2625-S-3
4 Segment (60 cm)	2625-S-T-4	2625-S-4
5 Segment (75 cm)	2625-S-T-5	2625-S-5
6 Segment (90 cm)	2625-S-T-6	2625-S-6
8 Segment (120 cm)	2625-S-T-8	2625-S-8

Simplify Measurement of Soil Moisture and Temperature at Multiple Depths

This **single GroPoint Profile probe** installed without excavation is **equivalent to 4 separate probes**. It measures soil moisture at 4 different depths simultaneously.

Create a pilot hole the exact size required for the probe using the slide hammer tool attached to a sturdy steel pilot rod. This makes installation quick and easy by eliminating any excavation, and provides minimum soil disruption, further increasing measurement accuracy.

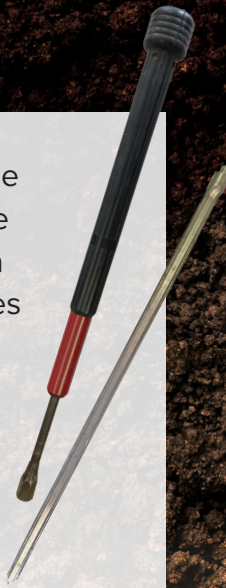

Segment 1
Average volumetric soil moisture content measured over 15cm (5.9")

Segment 2

Segment 3

Segment 4
Each segment can be calibrated independently.



Analyze water movement through the soil.

temperature sensor placement



Technical Specifications

* Specifications subject to change without notice.

MOISTURE

Measurement range	0% to 100% of VMC *
Accuracy	±2.0% *
Precision	< 0.2%

TEMPERATURE

Measurement range	-20°C to +70°C (-4°F to 158°F)
Accuracy	±0.5°C
Location	Surface every 10 or 15cm, depending on product length

ELECTRICAL

Output	SDI-12 V1.3 (RS485 optional) & MODBUS RTU
Connection	Bare wire (M12-5 code A male)
Input voltage	6 to 14 VDC max. 18 VDC
Current consumption	Quiescent: <0.5mA Active: 15-25 mA (depending on number of segments) for 100 ms per segment
Warm-up time on power up	< 1 second

ENVIRONMENTAL

Operating temperature	-20°C to +70°C (-4°F to 158°F)
Storage temperature	-40°C to 85°C (-40°F to 185°F)

PHYSICAL

Length	Each segment is approximately 15 cm (5.9") long. Total length is the number of segments multiplied by 15 cm. For example, a 3-segment probe is about 45cm long.
Probe weight	2 segments: 292 g (10.3 oz.) 3 segments: 351 g (12.4 oz.) 4 segments: 408 g (14.4 oz.) 5 segments: 468 g (16.5 oz.) 6 segments: 526 g (18.6 oz.) 8 segments: 642 g (22.6 oz.)
Cable weight	38 g per m (0.42 oz. per foot)
Standard cable	3m (9.8 ft.) or 5 m (16.3 ft.) 5x22AWG twisted pair, rated for direct burial
Warranty	1-year limited parts and labour

* 8% to 42% VMC, in controlled laboratory conditions; factory calibrated for most agricultural soils. In field applications, accuracy may slightly decrease due to the inevitable heterogeneity of soil texture, soil compaction, moisture and fluctuation in soil temperature. The accuracy may also decrease in difficult soil conditions (higher clay and salinity content). In normal conditions, GroPoint sensors will maintain their accuracy from permanent wilting through field capacity in sandy loam through clay soils with less than 60% clay particles. Under moderately saline conditions. GroPoint sensors will maintain their accuracy up to 6 ds/m.

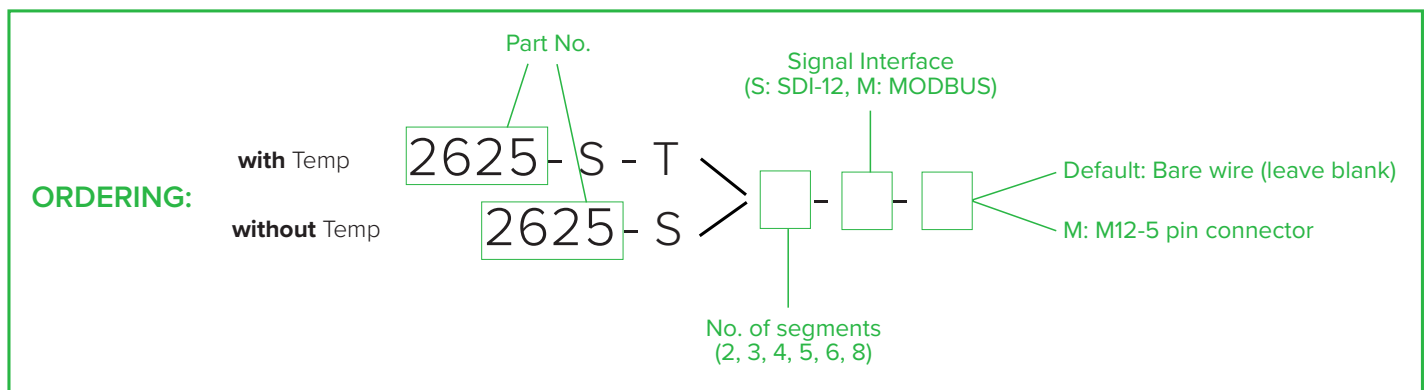

Or easily configure and order online at:
www.gropoint.com/products/soil-sensors/gropoint-profile/



About



GroPoint Products are manufactured in Canada by RioT Technology Corp.

In 2016, RioT Technology Corp. acquired the GroPoint™ brand.

We also hired several longstanding employees of ESI who had manufactured and designed the original MoisturePoint and GroPoint products. As such, we have the historical expertise for all GroPoint products in-house and available to assist former clients of ESI, and new clients interested in leveraging over 25 years of soil monitoring expertise.

TECHNOLOGY CORP.